

**Informação técnica**  
Information technique  
Información técnica  
Technical information

**Portas de Correr / Portes coulissantes / Puertas correderas / Sliding doors**

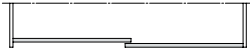

**2 Portas**  
**2 Portes**  
 2 Puertas  
 2 Doors



**3 Portas**  
**3 Portes**  
 3 Puertas  
 3 Doors

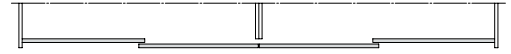

**4 Portas**  
**4 Portes**  
 4 Puertas  
 4 Doors

**Portas de correr - sistema HR / Portes coulissantes - système HR / Puertas correderas - sistema HR / Sliding doors - HR system**

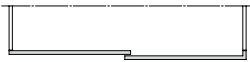

**2 Portas**  
**2 Portes**  
 2 Puertas  
 2 Doors



**3 Portas**  
**3 Portes**  
 3 Puertas  
 3 Doors

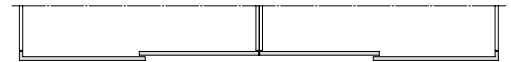

**4 Portas**  
**4 Portes**  
 4 Puertas  
 4 Doors

**Portas de batente / Portes battantes / Puertas abatibles / Hinged doors**

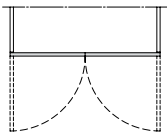

**2 Portas**  
**2 Portes**  
 2 Puertas  
 2 Doors

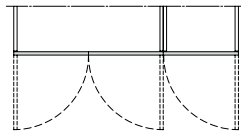

**3 Portas**  
**3 Portes**  
 3 Puertas  
 3 Doors

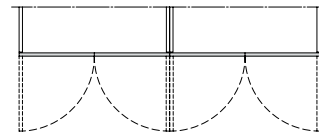

**4 Portas**  
**4 Portes**  
 4 Puertas  
 4 Doors

**Portas em fole / Portes pliantes / Puertas plegables / Folding doors**

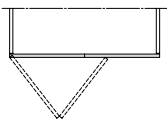

**2 Portas**  
**2 Portes**  
 2 Puertas  
 2 Doors

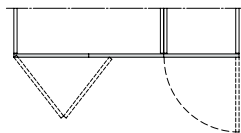

**3 Portas**  
**3 Portes**  
 3 Puertas  
 3 Doors

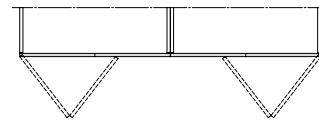

**4 Portas**  
**4 Portes**  
 4 Puertas  
 4 Doors

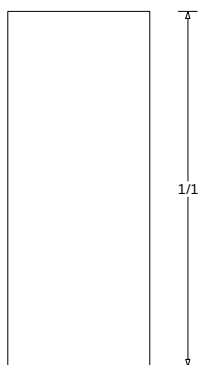

P1

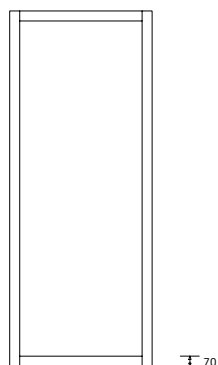

70

P1m

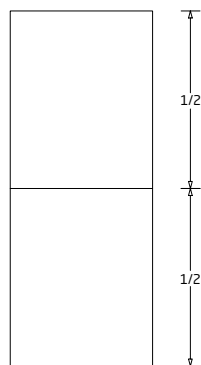

P2

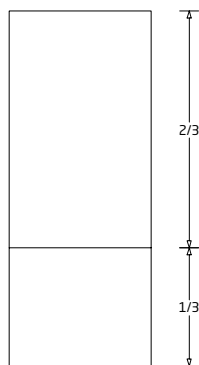

P2a

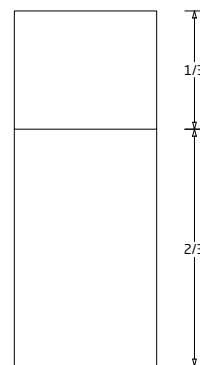

P2b

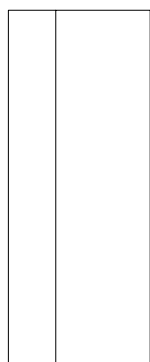

P2v

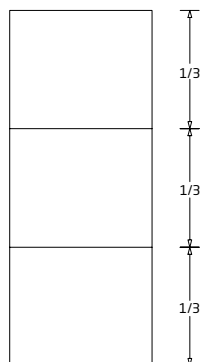

P3

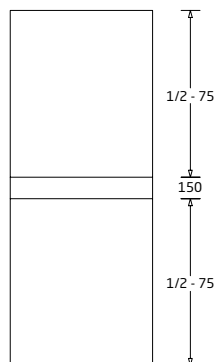

P3a

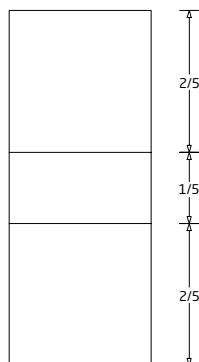

P3b

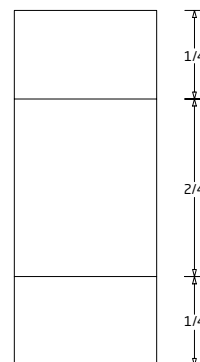

P3c

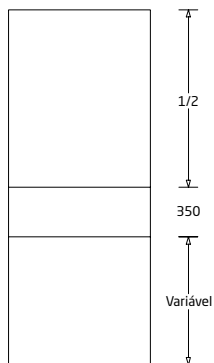

P3d

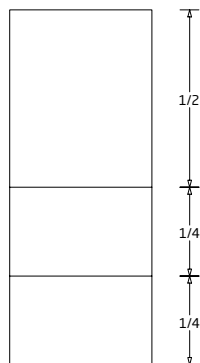

P3e

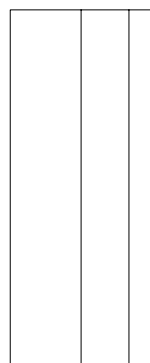

P3v

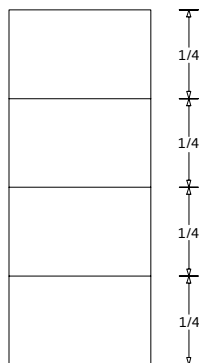

P4

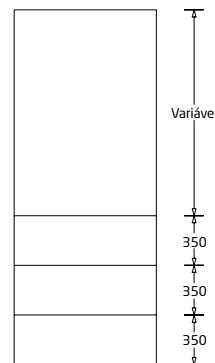

P4a

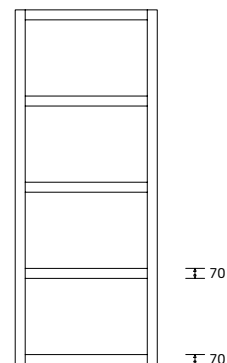

70

P4m

**Portas de correr**  
**Portes coulissantes**  
 Puertas correderas  
 Sliding doors

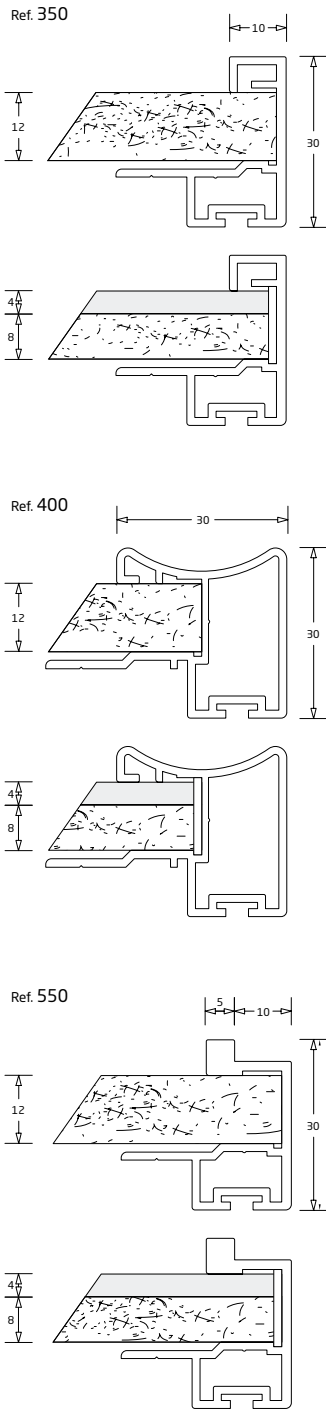

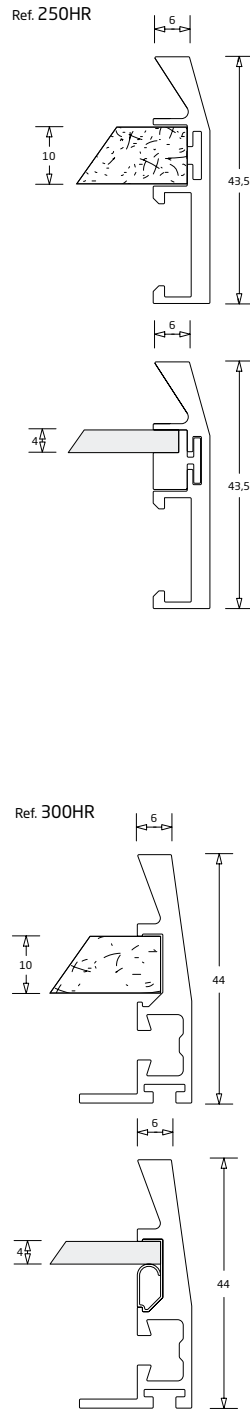

**Portas de correr - sistema HR**  
**Portes coulissantes - système HR**  
 Puertas correderas - sistema HR  
 Sliding doors - HR system

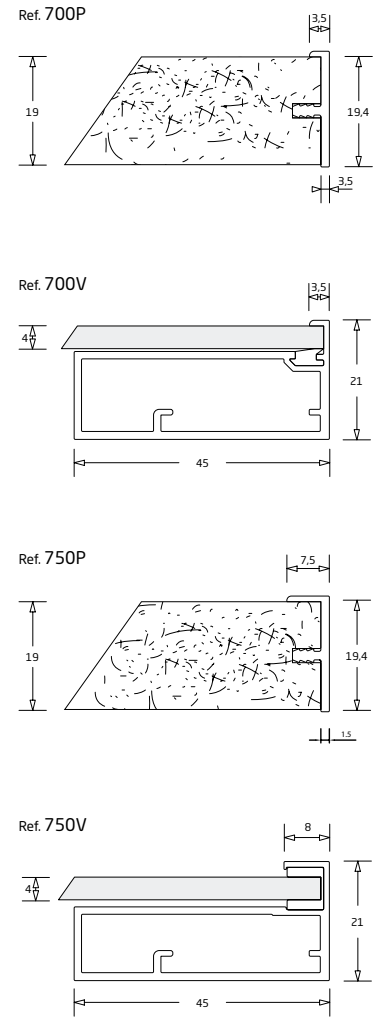

**Portas de batente ou foie**  
**Portes battantes ou pliantes**  
 Puertas abatibles o plegables  
 Hinged or folding doors



 Vidro / Verre / Cristal / Glass  
 Placa / Panneau / Tablero / Panel

Acabamentos Finitions Acabados Finishes	Prata Argent Plata Silver	Inox Inox Inox Stainless steel	Branco Blanc Blanco White	Preto Noir Negro Black	Melamina Mélamine Melamina Melamine	Folha madeira Placage bois Rechapado madera Wood veneer
<b>350</b>	S	S	S	S	-	-
<b>400 (1)</b>	S	S	S	S	S	S
<b>550</b>	S	S	S	S	-	-
<b>250HR</b>	S	-	S	S	-	-
<b>300HR</b>	S	-	S	S	-	-
<b>700P</b>	S	S	S	S	-	-
<b>700V</b>	S	S	S	S	-	-
<b>750P</b>	S	S	S	S	-	-
<b>750V</b>	S	S	S	S	-	-

**(1) Consultar revestimentos na página 113**  
**(1) Consultez les revêtements dans la page 113**  
 (1) Consultar rechapados en la página 113  
 (1) Check finishes in page 113

**Puxadores para portas de batente ou fole**  
**Poignées pour portes battantes ou pliantes**  
**Tiradores para puertas abatibles o plegables**  
 Handles for hinged or folding doors



Ref. 323

100 x 37 x 11



Ref. 685

210 x 30 x 25



Ref. 915

140 x 16 x 37



Ref. 929

188 x Ø12

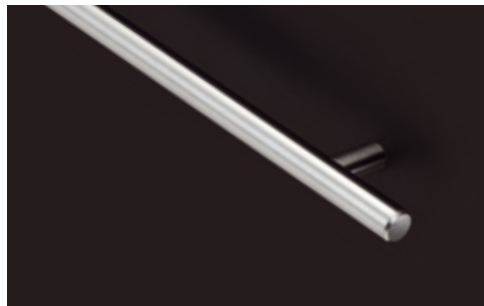

Ref. 930

528 x Ø14

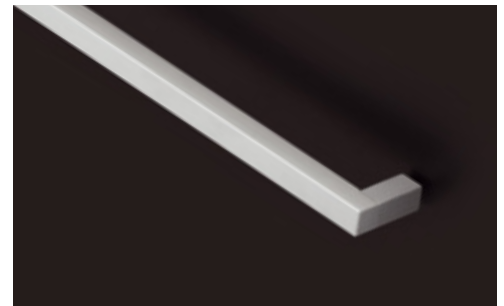

Ref. 932

490 x 11.6 x 12

**Puxadores para gavetas**  
**Poignées pour tiroirs**  
**Tiradores para cajones**  
 Drawers handles

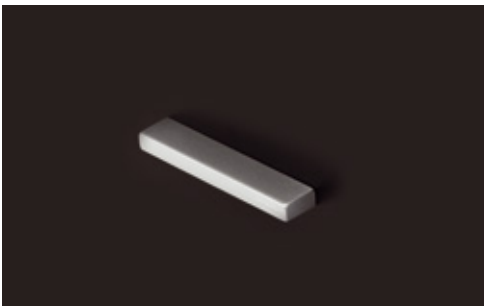

Ref. 734 (STD)

106 x 10 x 20



Ref. 790

106 x 16 x 16



Ref. 772

16 x 16 x 20



Ref. 774

150 x 16 x 8



Ref. 1233

150 x 19 x 8



Ref. 1227

51 x 51 x 14

**Blocos de gavetas**  
**Blocs de tiroirs**  
 Cajoneras  
 Drawers boxes

**Gaveta STD / Tiroir STD / Cajón STD / Drawer STD**

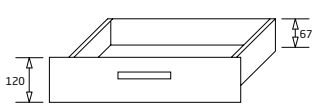

**STD 120**

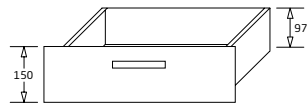

**STD 150**

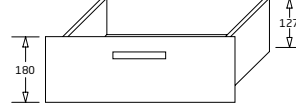

**STD 180**

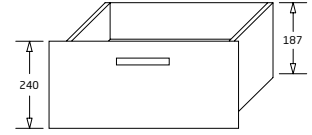

**STD 240**

**Gaveta VR / Tiroir VR / Cajón VR / Drawer VR**

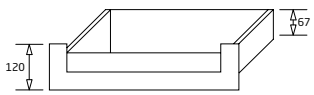

**VR 120**

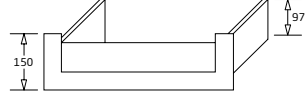

**VR 150**

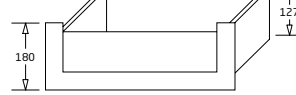

**VR 180**

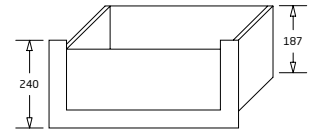

**VR 240**

**Gaveta PR / Tiroir PR / Cajón PR / Drawer PR**

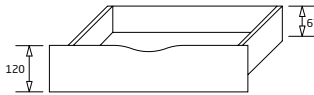

**PR 120**



**PR 150**



**PR 180**

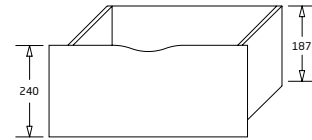

**PR 240**

**Gaveta TT (tic-tac) / Tiroir TT (pousse-lache) / Cajón TT (tic-tac) / Drawer TT (push-pull)**

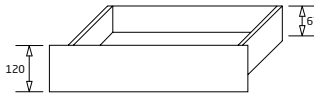

**TT 120**

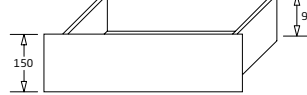

**TT 150**

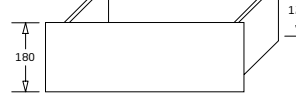

**TT 180**

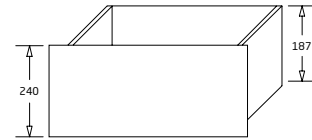

**TT 240**

**Gaveta TRD / Tiroir TRD / Cajón TRD / Drawer TRD**

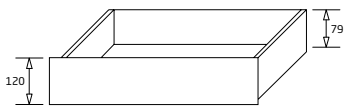

**TRD 120**

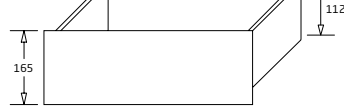

**TRD 165**

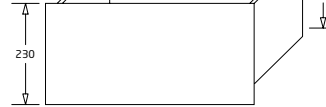

**TRD 230**

**Bloco de gavetas / Bloc de tiroirs / Cajonera / Drawers box**

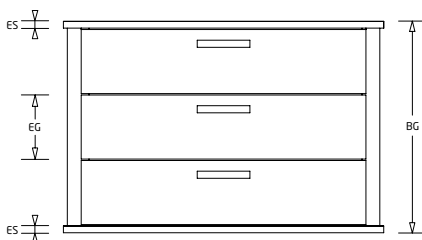

**STD, VR, PR, TT**

$$BG = (EG + EG + EG) + (QD + 1) \times 4 + 2 \times ES$$

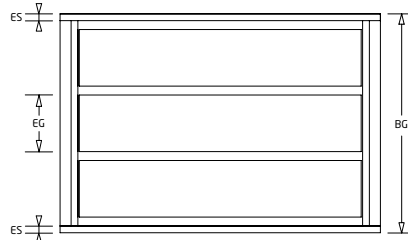

**TRD**

$$BG = (EG + EG + EG) + (QD + 1) \times 25 + 2 \times ES$$

**BG: Altura do bloco de gavetas**  
**BG: Hauteur du bloc de tiroirs**  
**BG: Altura del la cajonera**  
 BG: Drawers box height

**QD: Número de gavetas**  
**QD: Nombre de tiroirs**  
**QD: Número de cajones**  
 QD: Drawers number

**EG: Altura da gaveta**  
**EG: Hauteur du tiroir**  
**EG: Altura del cajón**  
 EG: Drawer's height

**ES: Espessura do painel**  
**ES: Épaisseur du panneau**  
**ES: Espesor del tablero**  
 ES: Panel thickness

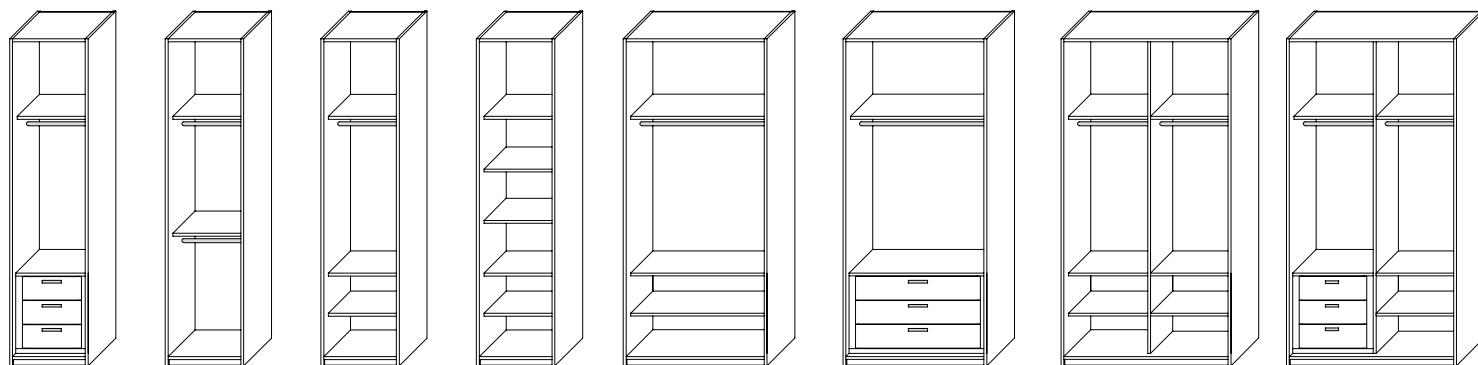

**M1a**      **M1b**      **M1c**      **M1d**      **M2a**      **M2b**      **M2c**      **M2d**



**C2a**      **C2b**      **C2c**      **C2d**

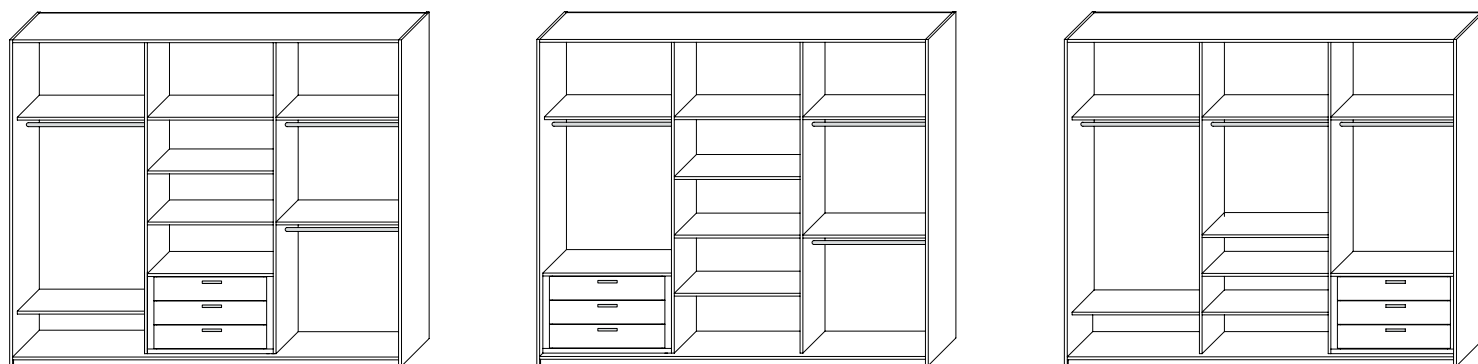

**C3a**      **C3b**      **C3c**

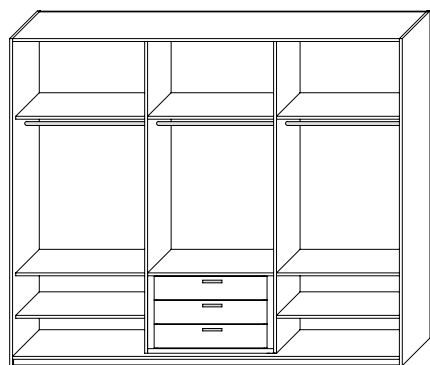

**C3d**

**M1a > M2d**  
**Roupeiros com portas de batente ou folde**  
**Placards à portes battantes ou pliantes**  
 Armarios com portas abatíveis o plegables  
 Closets with hinged or folding doors

**C2a > C3d**  
**Roupeiros com portas de correr**  
**Placards à portes coulissantes**  
 Armarios com portas correderas  
 Closets with sliding doors

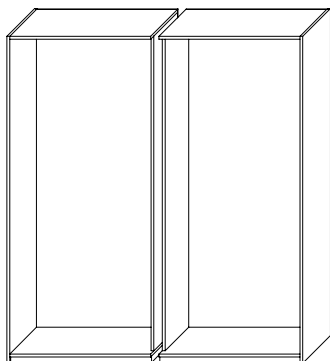

Opcional | **2 portas de correr**  
 Optionel | **2 portes coulissantes**  
 Opcional | **2 puertas correderas**  
 Optional | 2 sliding doors

Opcional | **2 portas de batente ou fole**  
 Optionel | **2 portes battantes ou pliantes**  
 Opcional | **2 puertas abatibles o plegables**  
 Optional | 2 hinged or folding doors

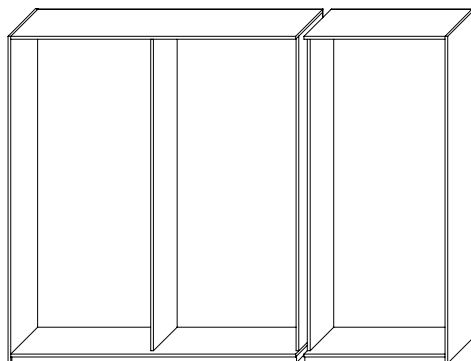

Opcional | **3 portas de correr**  
 Optionel | **3 portes coulissantes**  
 Opcional | **3 puertas correderas**  
 Optional | 3 sliding doors

Standard | **3 portas de batente ou fole**  
 Standard | **3 portes battantes ou pliantes**  
 Estándar | **3 puertas abatibles o plegables**  
 Standard | 3 hinged or folding doors

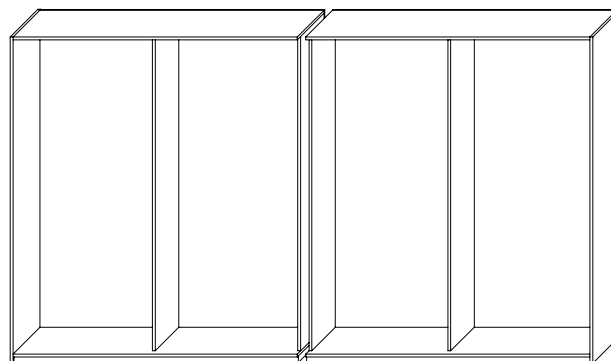

Standard | **4 portas de correr**  
 Standard | **4 portes coulissantes**  
 Estándar | **4 puertas correderas**  
 Standard | 4 sliding doors

Standard | **4 portas de batente ou fole**  
 Standard | **4 portes battantes ou pliantes**  
 Estándar | **4 puertas abatibles o plegables**  
 Standard | 4 hinged or folding doors

**Interior de roupeiro em "L"**  
**Intérieur de placard en "L"**  
 Interior de armario en "L"  
 Closet interior in "L"

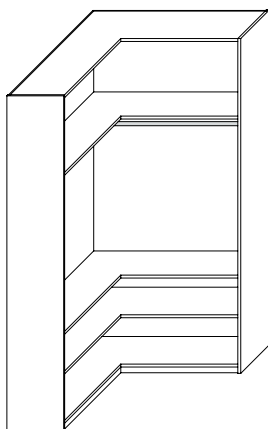

**Tipo A**  
**Type A**  
 Tipo A  
 Type A

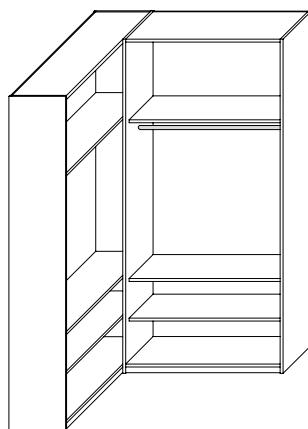

**Tipo F**  
**Type F**  
 Tipo F  
 Type F



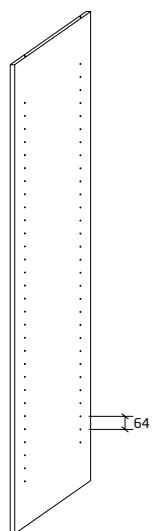

**MF 64**

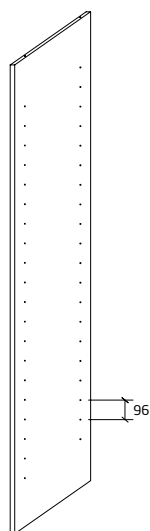

**MF 96**

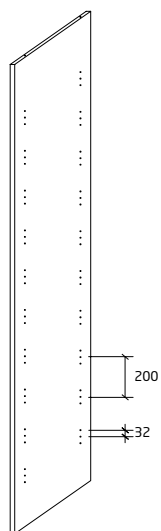

**MF 200**



**SMF**

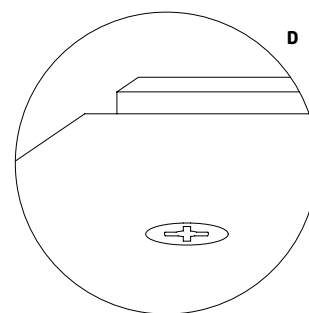
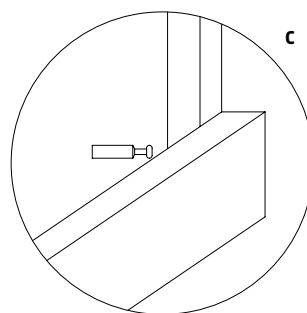
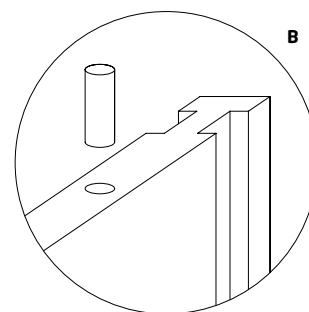
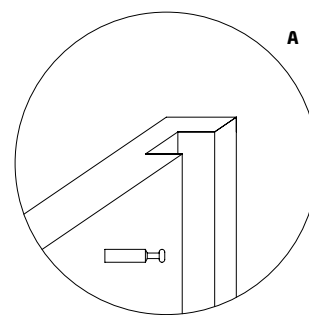
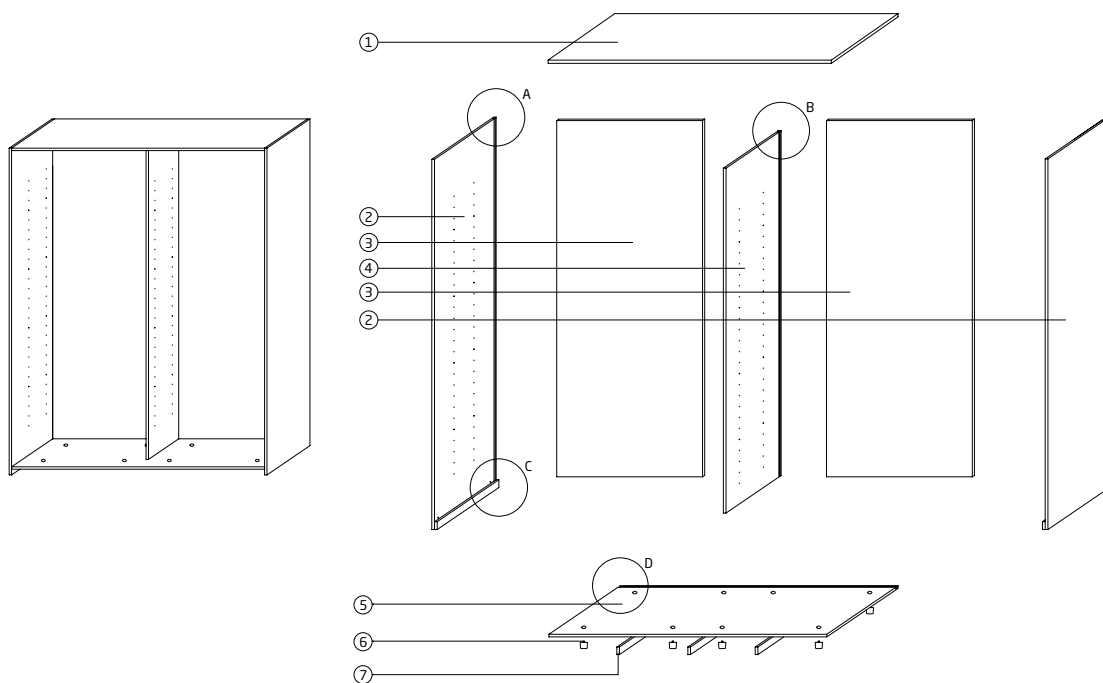

**Sistema de montagem**  
**Système de montage**  
 Sistema de montaje  
 Assembly system

- 1 - Topo / Partie haute / Techo / Ceiling**
- 2 - Lateral / Joue / Costado / Lateral**
- 3 - Costa / Fond / Trasera / Back**
- 4 - Divisória / Montant / Separador / Divider**
- 5 - Fundo / Partie basse / Suelo / Floor**
- 6 - Nivelador / Pied réglable / Nivelador / Adjustable leveller**
- 7 - Reforço do fundo / Renfort de la partie basse / Refuerzo del suelo / Floor reinforcement**

**Medidas standard para interiores de roupeiros**  
**Mesures standard pour intérieurs de placards**  
**Medidas estándar para interiores de armarios**  
 Standard dimensions for the interior of closets

Roupeiros com portas de correr Placards à portes coulissantes Armarios con puertas correderas Closets with sliding doors			Roupeiros com portas de correr - sistema HR Placards à portes coulissantes - système HR Armarios con puertas correderas - sistema HR Closets with sliding doors - HR system			Roupeiros com portas de batente Placards à portes battantes Armarios con puertas abatibles Closets with hinged doors			Roupeiros com portas em folo Placards à portes pliantes Armarios con puertas plegables Closets with folding doors		
Módulo interior Module intérieur Módulo interior Interior module	Divisória Montant Separador Divider	Prateleira Etagère Balda Shelf	Módulo interior Module intérieur Módulo interior Interior module	Divisória Montant Separador Divider	Prateleira Etagère Balda Shelf	Módulo interior Module intérieur Módulo interior Interior module	Divisória Montant Separador Divider	Prateleira Etagère Balda Shelf	Módulo interior Module intérieur Módulo interior Interior module	Divisória Montant Separador Divider	Prateleira Etagère Balda Shelf
400	280	275	400	350	345	400	380	300	400	305	300
425	305	300	425	375	370	425	405	325	425	330	325
450	330	325	450	400	395	450	430	350	450	355	350
475	355	350	475	425	420	475	455	375	475	380	375
500	380	375	500	450	445	500	480	400	500	405	400
525	405	400	525	475	470	525	505	425	525	430	425
550	430	425	550	500	495	550	530	450	550	455	450
575	455	450	575	525	520	575	555	475	575	480	475
600	480	475	600	550	545	600	580	500	600	505	500
625	505	500	625	575	570	625	605	525	625	530	525
650	530	525	650	600	595	650	630	550	650	555	550
675	555	550	675	625	620	675	655	575	675	580	575

**Profundidades standard (mm) conforme tabela**  
**Profondeurs standard (mm) comme dans le tableau**  
**Fondos estándar (mm) de acuerdo con tabla**  
 Standard depth (mm) as table

**As alturas e larguras dos roupeiros não obedecem a medidas standard, considerando no entanto, uma altura máxima para fabrico de 2600 mm.**  
**Les hauteurs et les largeurs des placards n'obligent pas aux mesures standard, cependant, il faut considéré une hauteur maximale de 2600 mm pour la fabrication.**  
 Las alturas y las anchuras de los armarios no requieren medidas estándar, sin embargo, se considera una altura máxima de fabricación de 2600 mm.  
 Heights and widths don't meet standard dimensions, however, 2600 mm are considered for maximum height production.

<b>Acessórios</b> Accessoires Accesorios Accessories	<b>Ref°</b> Réf. Ref.	<b>Dimensão (LxP)</b> Dimensión (L x P) Dimensión (L x F) Dimension (W x D)	<b>Espaço ocupado (LxP)</b> Espace occupé (L x P) Espacio ocupado (L x F) Occupied space (W x D)
<b>Sapateira</b> / Porte-chaussures / Cajón zapatero / Shoes-holder	69148	445 x 441	565 x 510
<b>Sapateira</b> / Porte-chaussures / Cajón zapatero / Shoes-holder	69149	595 x 441	715 x 510
<b>Sapateira</b> / Porte-chaussures / Cajón zapatero / Shoes-holder	69150	745 x 441	865 x 510
<b>Sapateira lateral</b> / Porte-chaussures latéral / Zapatero lateral / Lateral shoes-holder	69221	250 x 510	260 x 510
<b>Porta-calças</b> / Cajón de pantalono / Porte-pantalons / Trousers-holder	69152	(305 > 1200) x 510	(410 > 1300) x 510
<b>Porta-calças</b> / Porte-pantalons / Pantalono / Trousers-holder	69128	350 x 500	360 x 500
<b>Porta-cintos</b> / Porte-ceintures / Portacinturones / Belts-holder	69218	90 x 510	100 x 510
<b>Porta-gravatas</b> / Porte-cravates / Corbatero / Ties-holder	69216	90 x 510	100 x 510
<b>Gaveta quadrículada</b> / Tiroir organisateur / Cajón organizador / Checkered drawer	69155	445 x 445	565 x 510
<b>Cesto em verga</b> / Corbeille en osier / Cajón de ratán / Wicker basket (140 mm)	69142	440 x 441	560 x 510
<b>Cesto em verga</b> / Corbeille en osier / Cajón de ratán / Wicker basket (140 mm)	69143	590 x 441	710 x 510
<b>Cesto em verga</b> / Corbeille en osier / Cajón de ratán / Wicker basket (140 mm)	69144	740 x 441	860 x 510
<b>Cesto em verga</b> / Corbeille en osier / Cajón de ratán / Wicker basket (210 mm)	69145	440 x 441	560 x 510
<b>Cesto em verga</b> / Corbeille en osier / Cajón de ratán / Wicker basket (210 mm)	69146	590 x 441	710 x 510
<b>Cesto em verga</b> / Corbeille en osier / Cajón de ratán / Wicker basket (210 mm)	69147	740 x 441	860 x 510
<b>Cesto metálico</b> / Corbeille métallique / Cajón metálico / Metal basket (87 mm)	69133	437 x 441	557 x 510
<b>Cesto metálico</b> / Corbeille métallique / Cajón metálico / Metal basket (87 mm)	69134	587 x 441	707 x 510
<b>Cesto metálico</b> / Corbeille métallique / Cajón metálico / Metal basket (87 mm)	69135	737 x 441	857 x 510
<b>Cesto metálico</b> / Corbeille métallique / Cajón metálico / Metal basket (140 mm)	69136	437 x 441	557 x 510
<b>Cesto metálico</b> / Corbeille métallique / Cajón metálico / Metal basket (140 mm)	69137	587 x 441	707 x 510
<b>Cesto metálico</b> / Corbeille métallique / Cajón metálico / Metal basket (140 mm)	69138	737 x 441	857 x 510
<b>Cesto metálico</b> / Corbeille métallique / Cajón metálico / Metal basket (275 mm)	69139	437 x 441	557 x 510
<b>Cesto metálico</b> / Corbeille métallique / Cajón metálico / Metal basket (275 mm)	69140	587 x 441	707 x 510
<b>Cesto metálico</b> / Corbeille métallique / Cajón metálico / Metal basket (275 mm)	69141	737 x 441	857 x 510
<b>Varão trombone</b> / Tringle extractible / Colgador extraíble / Pull-out hanging bar	69163	80 x 425	500 x 425
<b>Varão LED com sensor</b> / Tringle LED avec détecteur / Barra colgar LED con sensor / Clothes bar with LED and sensor	70021	408 x 558	-
<b>Varão LED com sensor</b> / Tringle LED avec détecteur / Barra colgar LED con sensor / Clothes bar with LED and sensor	70022	558 x 708	-
<b>Varão LED com sensor</b> / Tringle LED avec détecteur / Barra colgar LED con sensor / Clothes bar with LED and sensor	70023	708 x 858	-
<b>Varão LED com sensor</b> / Tringle LED avec détecteur / Barra colgar LED con sensor / Clothes bar with LED and sensor	70024	858 x 1008	-
<b>Varão LED com sensor</b> / Tringle LED avec détecteur / Barra colgar LED con sensor / Clothes bar with LED and sensor	70025	1008 x 1158	-
<b>Varão basculante</b> / Tringle télescopique / Colgador abatible / Lift clothes bar	92837	450 x 600	-
<b>Varão basculante</b> / Tringle télescopique / Colgador abatible / Lift clothes bar	92838	600 x 830	-
<b>Varão basculante</b> / Tringle télescopique / Colgador abatible / Lift clothes bar	92839	830 x 1150	-

**Roupeiros com portas de correr**  
**Placards à portes coulissantes**  
**Armarios con puertas correderas**  
**Closets with sliding doors**

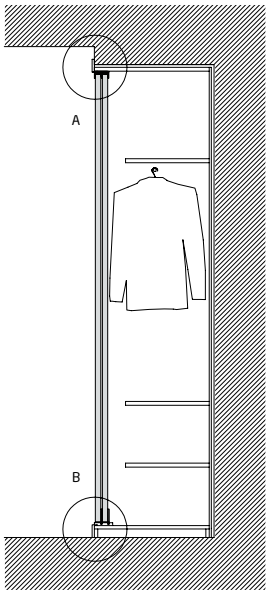

**Pavimento/Gola**  
**Plancher/Poutre**  
**Suelo/Pared**  
**Floor/Wall**

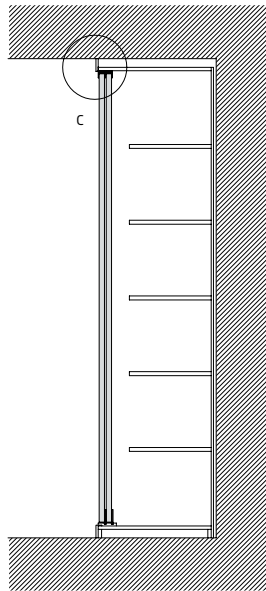

**Pavimento/Teto**  
**Plancher/Plafond**  
**Suelo/Techo**  
**Floor/Ceiling**

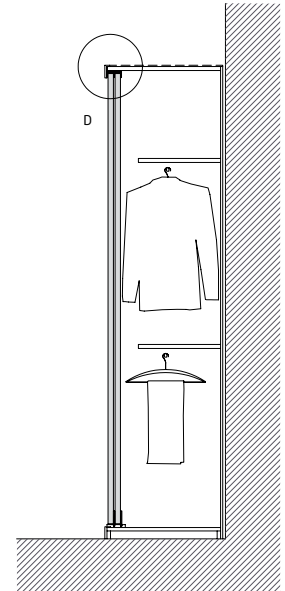

**Teto livre**  
**Plafond libre**  
**Techo libre**  
**Free ceiling**

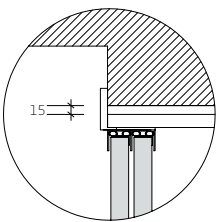

**A**

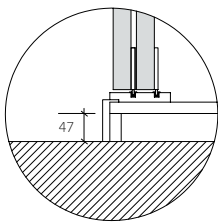

**B**

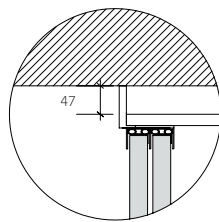

**C**

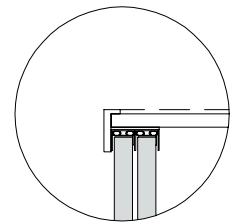

**D**

**Tipo / Type / Tipo / Type - G2**

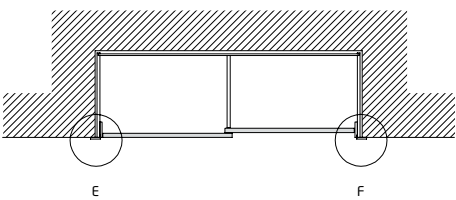

**E**

**F**

**Tipo / Type / Tipo / Type - G1**

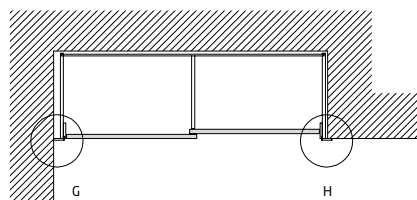

**G**

**H**

**Tipo / Type / Tipo / Type - G0**

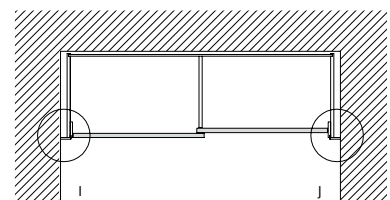

**I**

**J**

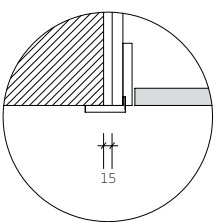

**E**

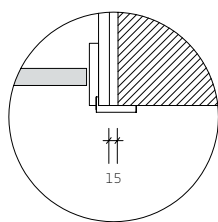

**F**

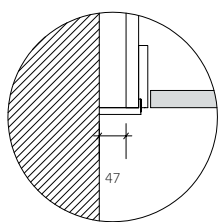

**G**

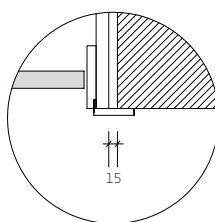

**H**

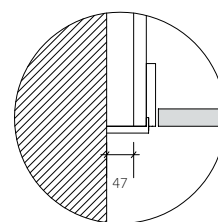

**I**

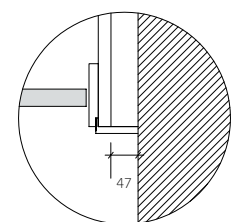

**J**

**Roupeiros com portas de correr - sistema HR (calha oculta)**  
**Placards à portes coulissantes - système HR (rail caché)**  
**Armarios con puertas correderas - sistema HR (carril oculto)**  
 Closets with sliding doors - HR system (hidden rail)

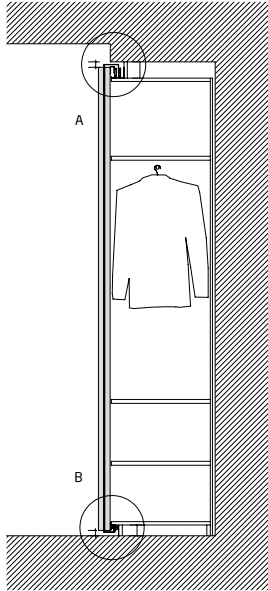

**Pavimento/Gola**  
**Plancher/Poutre**  
 Suelo/Pared  
 Floor/Wal

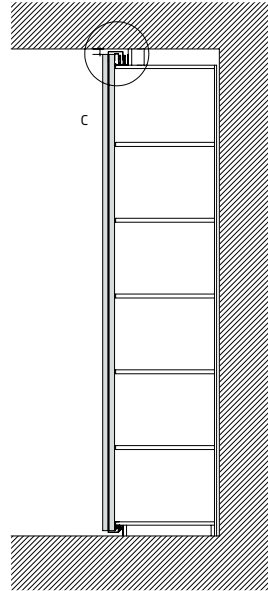

**Pavimento/Teto**  
**Plancher/Plafond**  
 Suelo/Techo  
 Floor/Ceiling

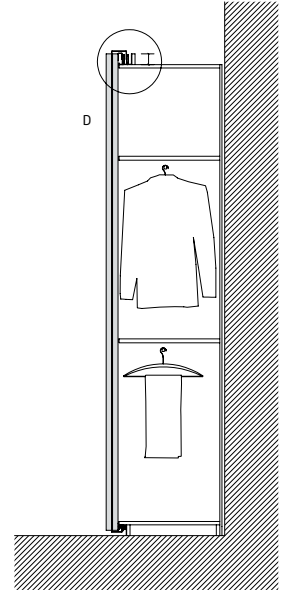

**Teto livre**  
**Plafond libre**  
 Techo libre  
 Free ceiling

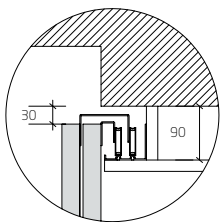

**A**

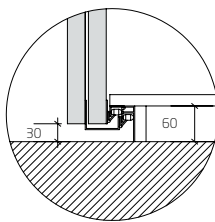

**B**

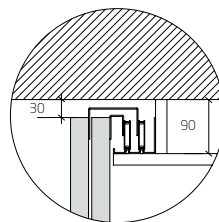

**C**

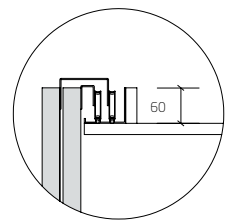

**D**

**Tipo / Type / Tipo / Type - G2**

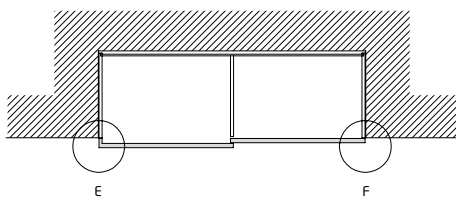

**E**

**F**

**Tipo / Type / Tipo / Type - G1**

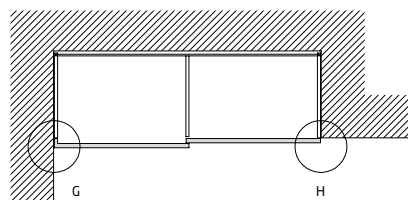

**G**

**H**

**Tipo / Type / Tipo / Type - G0**

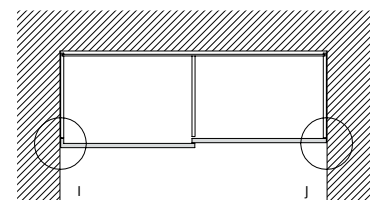

**I**

**J**

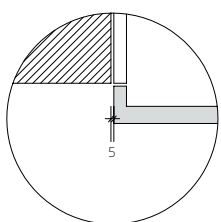

**E**

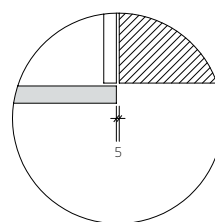

**F**

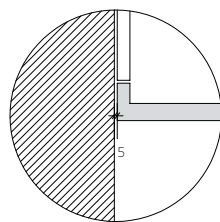

**G**

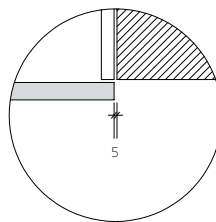

**H**

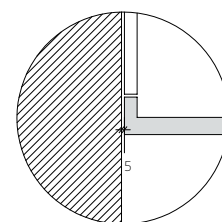

**I**

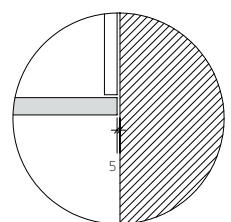

**J**

**Roupeiros com portas de batente ou fole (com guarnição 70x19 mm)**  
**Placards à portes battantes ou pliantes (avec chambranles 70x19 mm)**  
**Armarios con puertas abatibles o plegables (con tapajuntas 70x19 mm)**  
 Closets with hinged or folding doors (with 70x19 mm architrave)

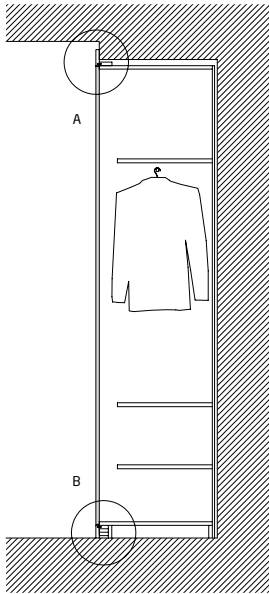

**Pavimento/Gola**  
**Plancher/Poutre**  
 Suelo/Pared  
 Floor/Wall

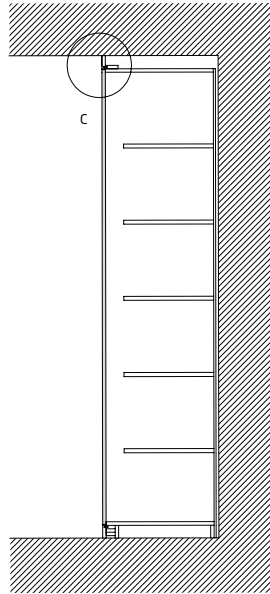

**Pavimento/Teto**  
**Plancher/Plafond**  
 Suelo/Techo  
 Floor/Ceiling

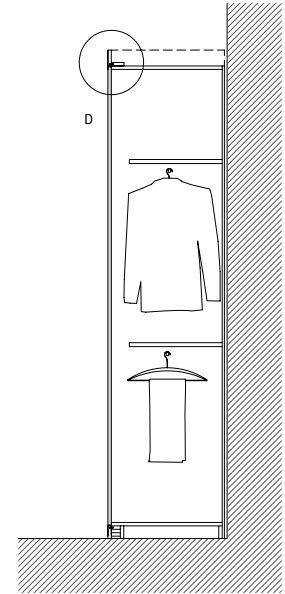

**Teto livre**  
**Plafond libre**  
 Techo libre  
 Free ceiling

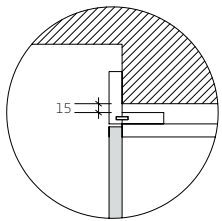

**A**

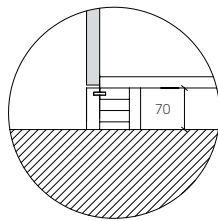

**B**

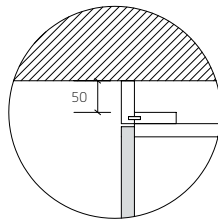

**C**

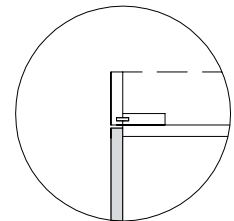

**D**

**Tipo / Type / Tipo / Type - G2**

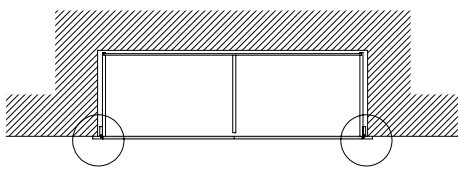

**E**

**F**

**Tipo / Type / Tipo / Type - G1**

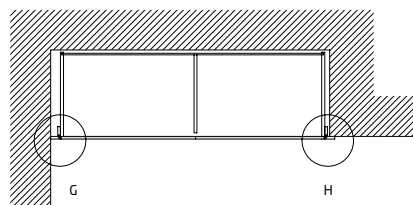

**G**

**H**

**Tipo / Type / Tipo / Type - G0**

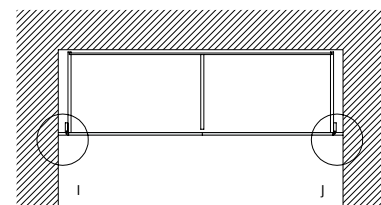

**I**

**J**

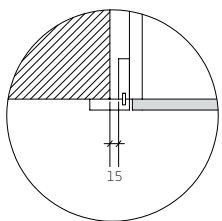

**E**

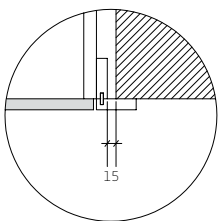

**F**

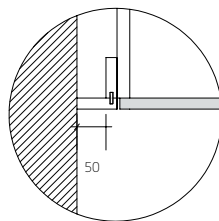

**G**

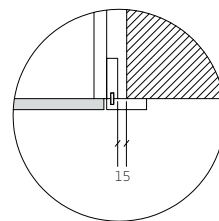

**H**

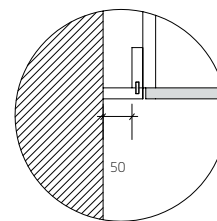

**I**

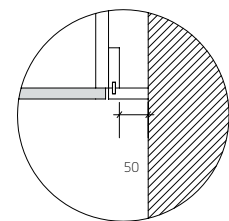

**J**

**Roupeiros com portas de batente ou fole (sem guarnição)**  
**Placards à portes battantes ou pliantes (sans chambranles)**  
 Armarios con puertas abatibles o plegables (sin tapajuntas)  
 Closets with hinged or folding doors (without architrave)

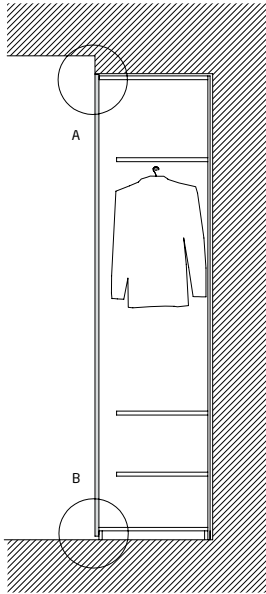

**Pavimento/Gola**  
**Plancher/Poutre**  
 Suelo/Pared  
 Floor/Wall

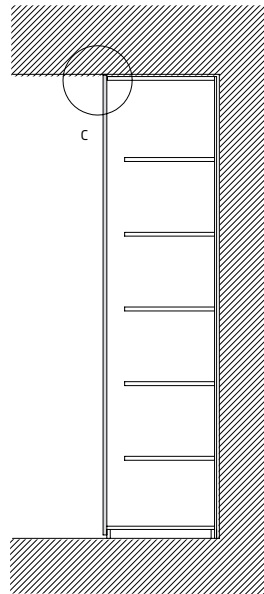

**Pavimento/Teto**  
**Plancher/Plafond**  
 Suelo/Techo  
 Floor/Ceiling

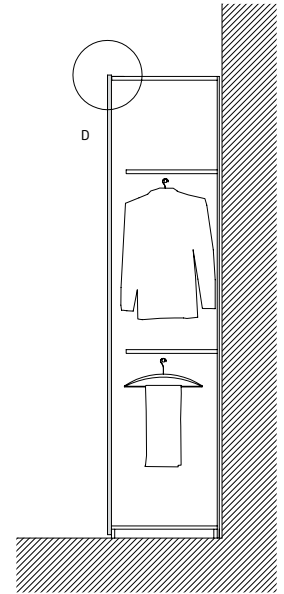

**Teto livre**  
**Plafond libre**  
 Techo libre  
 Free ceiling

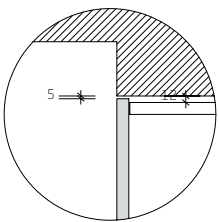

**A**

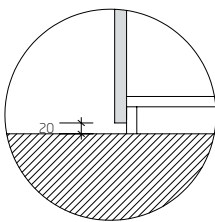

**B**

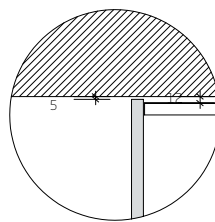

**C**

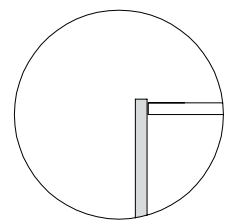

**D**

**Tipo / Type / Tipo / Type - G2**

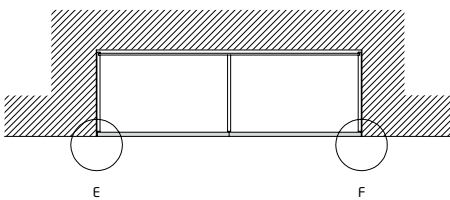

**E**

**F**

**Tipo / Type / Tipo / Type - G1**

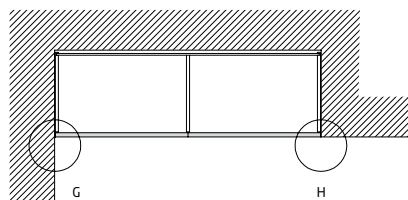

**G**

**H**

**Tipo / Type / Tipo / Type - G0**

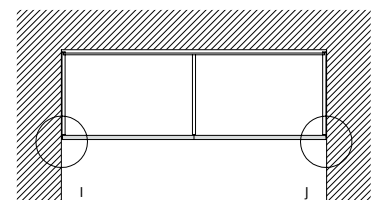

**I**

**J**

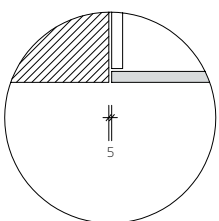

**E**

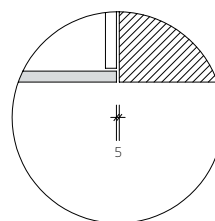

**F**

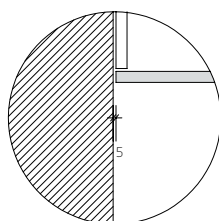

**G**

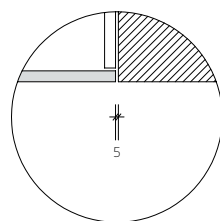

**H**

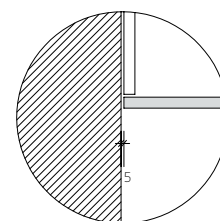

**I**

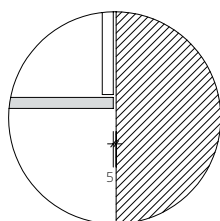

**J**